

PNEUMATIC SCRAP HANDLING SYSTEMS



BULLETIN 931



BloApCo[®]

A NAME SYNONYMOUS WITH QUALITY

BLOWER APPLICATION COMPANY, INC.

SINCE 1933

EXPERTISE TO MEET YOUR

TURNKEY SYSTEMS

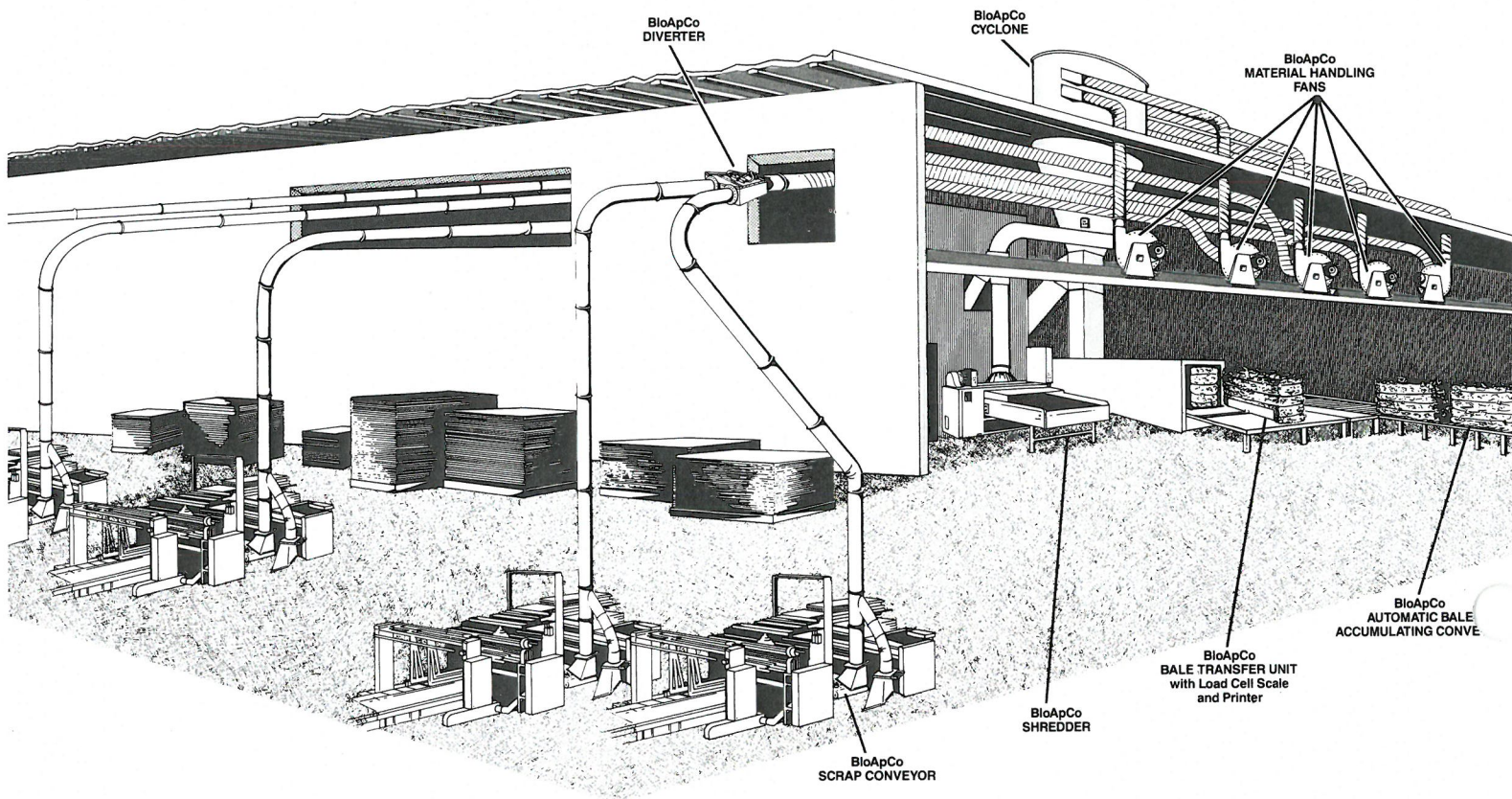

FROM INCEPTION – THRU DESIGN – MANUFACTURING – INSTALLATION – START-UP – AND BEYOND

You can count on BloApCo for a scrap handling system that will automatically remove your scrap — without the assistance of any operators. One that will operate day-in and day-out, 24 hours a day, 365 days a year with minimal maintenance, allowing the operators to concentrate on the quality of the finished product — not on getting rid of scrap. Removing and reselling of scrap automatically will increase your profits by allowing the equipment to operate to maximum capacity, and will improve product quality by permitting the operators to concentrate on production.

Single source responsibility to most other companies

means manufacturing some of the components but buying the majority from other vendors. To BloApCo it means selecting the proper component from the widest range of proven products and marrying them together into a total system.

Our services don't stop when the system is up and running — it extends beyond the successful installation, start-up and operating training phases. It includes complete engineering drawings of all of the equipment, an inventory of spare parts, plus a fully trained engineering staff to assist you with alterations or changes to the system in the future.

PLANT UPGRADES AND EXPANSIONS

• NEW CONVERTING PRESSES • RELOCATING EXISTING EQUIPMENT • REPLACING PROBLEM EQUIPMENT

The need to upgrade or expand an existing system presents a completely different set of challenges to the BloApCo engineer. The same depth of knowledge needed to design a new system is required, but now the BloApCo engineer is called upon to analyze the existing equipment to determine its capacity, capabilities and limitations. This is especially difficult when the equipment was manufactured by a company that is no longer in business, or cannot provide engineering data on the equipment. Depending upon the size of the existing system, this analysis process can take days.

Armed with the full knowledge of the characteristics of the existing system, plus an understanding of the expansion needs, the BloApCo engineer will return to layout both the existing system, plus the alterations required for its expansion. The difficulty of conceiving a revised system is especially complex because the existing system normally must remain as is. The BloApCo engineer will return to the plant to review several solutions — each one having advantages and disadvantages. BloApCo will work in concert with the plant staff resulting in a win-win situation.

New converting machine added to system.

By installing a BloApCo auto sequencing diverter, **no additional air** is required to accommodate the new equipment. Thus eliminating the need for a new cyclone or separator.

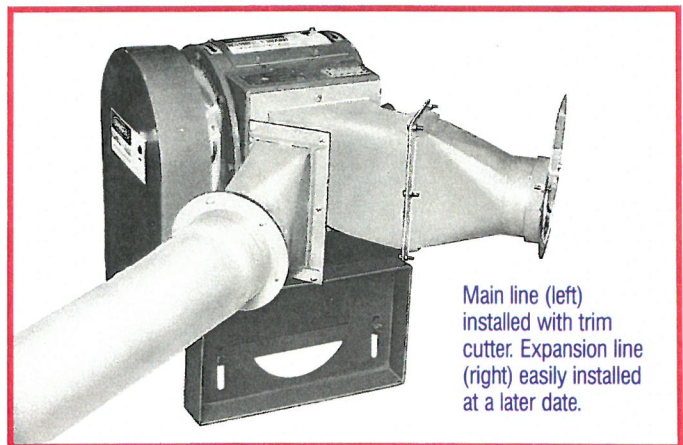
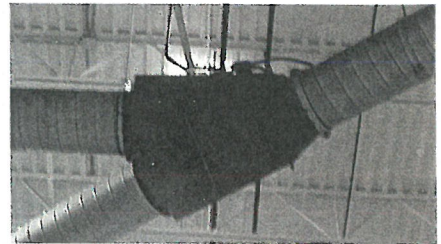

Main line (left) installed with trim cutter. Expansion line (right) easily installed at a later date.

SOLUTIONS TO EXISTING PROBLEMS

• CONSTANT PLUGGING • NEGATIVE PLANT PRESSURE • LOSS OF HEATED/COOLED AIR

Because of our 60+ years of experience in successfully handling all types of scrap, BloApCo is often called upon to troubleshoot existing system problems. The majority of these systems are working at levels far below plant expectations.

Systems that don't function properly are a welcomed challenge to our engineering capabilities — and we meet those challenges with the top quality expertise you have come to expect from BloApCo.

Our experienced engineers will analyze the system's problem(s) and develop several solutions based upon cost, down-time, etc. With this comprehensive information from our engineers, the plant staff can then make an informed decision as to which solution best meets their needs.

BloApCo's objective is to return your operation to its full capacity as quickly and cost effectively as possible.

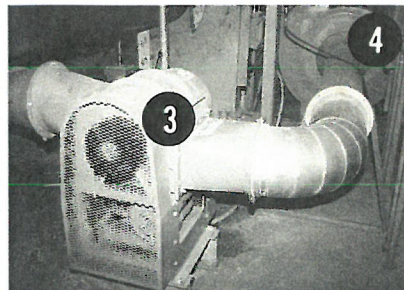
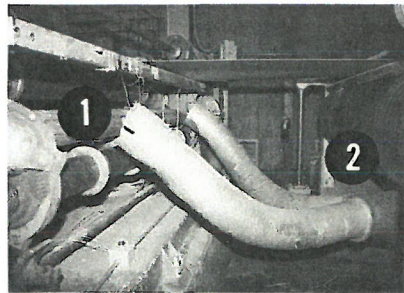

EXAMPLE:

Pneumatic scrap handling system could not handle two continuous thick and tough edge trims, causing duct plugging.

BloApCo Model 8-5 Trim Cutter installed in existing duct. Edge trims are picked up from the laminator (1). Strips converge at "Y" (2) and are fed into Trim Cutter (3), where scrap is cut and moved through larger duct to material handling fan (4). Addition of the Trim Cutter is the only change made to the entire system.

See Application Report 10 for complete details.

PROVEN PROPRIETARY

SHREDDERS

- LOW HORSEPOWER • ENERGY EFFICIENT • PATENTED PIERCE & TEAR ACTION

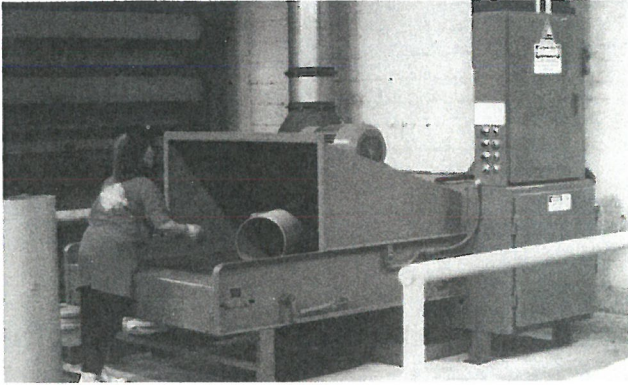

FOLDING
CARTON

CORRUGATED



DIE CUT
SCRAP

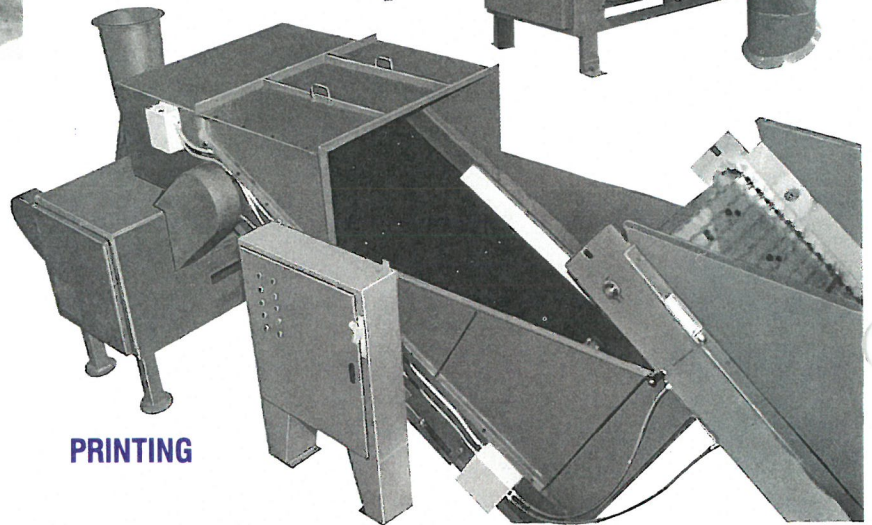

PRINTING

Heavy Duty Material Handling FANS

- 8 STANDARD MODELS • 500 to 28,000 CFM • FABRICATED FROM HIGH STRENGTH ALLOY STEEL.

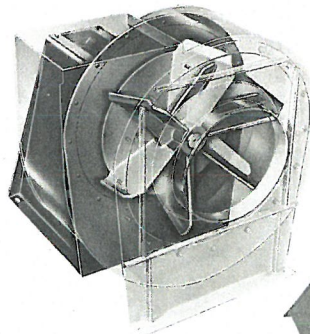
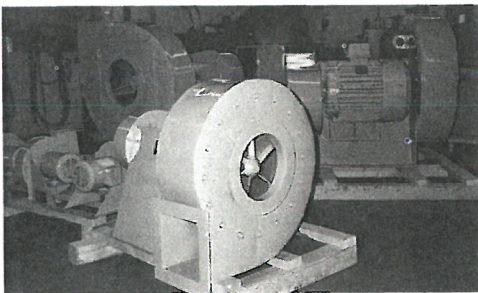

*The toughest
you can find!
Just put 'em in
and forget 'em!*

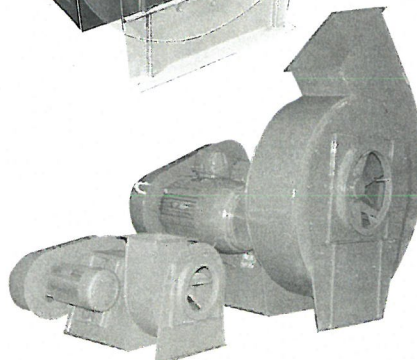
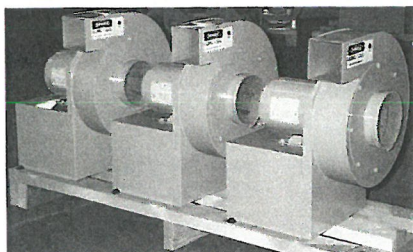
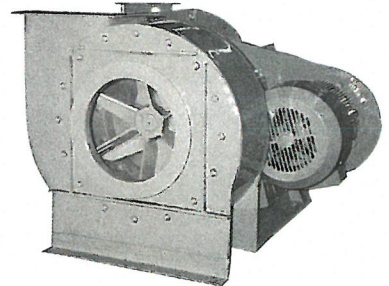

- SALES • DESIGN • ENGINEERING • FABRICATION • INSTALLATION

PRODUCTS

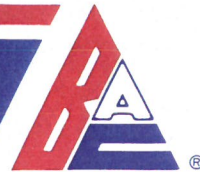

TRIM CUTTERS

- 8 STANDARD MODELS
- WIDE RANGE CUTTING CAPABILITIES — from thin ¼ mil films and foils to thick, heavy boards and metals.
- HEAVY CONSTRUCTION FOR RUGGED USE.

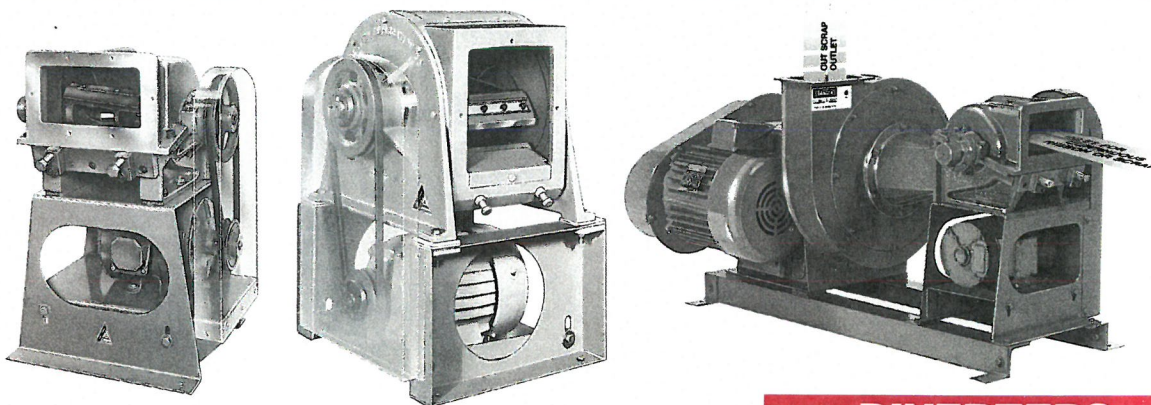

DIVERTERS

- UNIQUE BUCKET, SEALED FOR HIGH EFFICIENCY — WON'T CLOG.
- PRESSURE SIDE OR SUCTION SIDE SWITCHES AVAILABLE.
- PERMANENTLY LUBRICATED BEARINGS.
- AIR, ELECTRICALLY OR MANUALLY OPERATED.

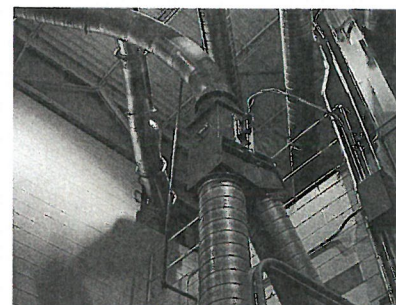
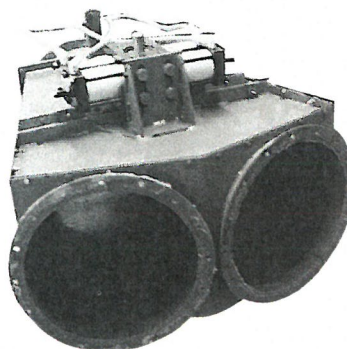

CYCLONES and SEPARATORS

MODELS FROM 1000 to 75,000 CFM, CUSTOM BUILT.

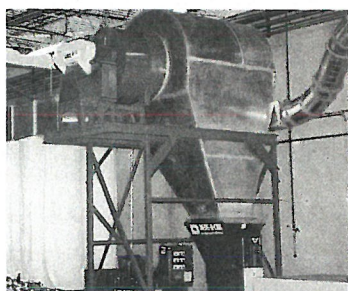

INDOOR

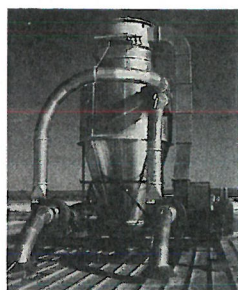

OUTDOOR

RETURN AIR and DUST COLLECTION

Typical Cyclone with built-in filter, return air fan and monitoring system. Pays for itself by returning the conditioned air back into the building.

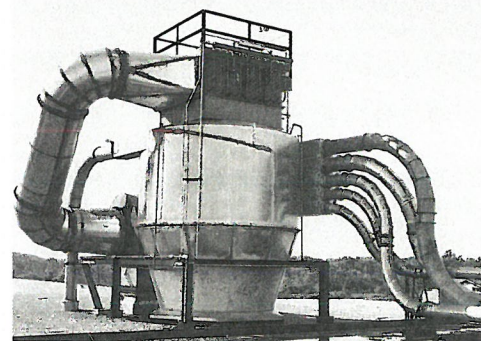

SEAL DRUM CONVEYORS

- USES 95% OUTSIDE AIR, ONLY 5% INSIDE AIR.
- FOR CONVERTING PRESSES AT CORRUGATED AND FOLDING CARTON PLANTS.



BALE TRANSFER UNITS

- FOR USE WITH AUTOMATIC BALERS
- HANDLES ANY SIZE BALE.
- USE WITH OR WITHOUT SCALE OR PRINTER.
- MINIMIZE HANDLING

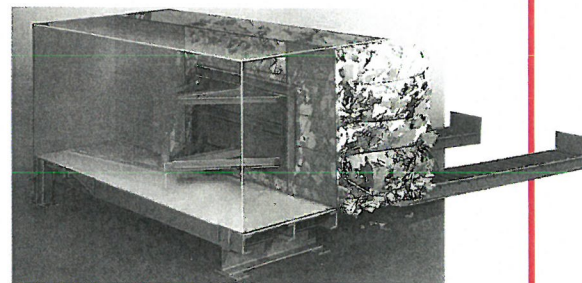

SINGLE SOURCE RESPONSIBILITY — PERFORMANCE GUARANTEED!

WHERE QUALITY BEGINS



COMPLETE ENGINEERING SERVICES

ON SITE ANALYSIS

Since each system, upgrade or problem, is different, BloApCo will send a highly qualified engineer to visit your plant and determine first hand what your needs and requirements are for today and in the future. The BloApCo engineer selected will be one that is familiar with your industry, thus making him uniquely qualified to recommend the best solution for your needs.

SYSTEM DESIGN

Using the experience gained from handling an extremely wide variety of scrap and from designing thousands of successful systems worldwide, we are able to adapt each component so that it becomes an integral part of the overall system. Utilizing the BloApCo application engineer guarantees proper selection of components for a totally tailored system design.

SOLUTIONS THAT WORK — GUARANTEED!

The many industries that we serve have come to know BloApCo as a trustworthy, reliable and dependable supplier. We know what it takes to provide a proven product that will stand up to the abuse of continuous operation. Because we will not tarnish our 60+ year legendary reputation, we guarantee every product we sell and put our name on.

SHEET METAL FABRICATION

QUALITY WORKMANSHIP

At BloApCo, metal fabrication is a skilled craft. Quality products are produced by seasoned craftsmen, using innovative technology and equipment. We utilize the latest CAD driven DNC plate burning equipment, coupled with state-of-the-art forming, bending, welding, metal cleaning and painting equipment.

ON TIME DELIVERY

Our overall materials resource planning system assures on-time delivery. This system includes an up-to-the-minute production control system, capacity planning and appropriate shop floor controls.

BloApCo takes pride in our commitment to on-time delivery.



FIELD INSTALLATION

BloApCo TRAINED FIELD CREWS MAKE THE DIFFERENCE

BloApCo Field Service Technicians install the system in your plant using skilled tradesmen. Our Technicians provide the logistics of manpower, equipment, components and supplies to ensure proper installation. We employ all our resources to minimize the disruption to your plant. Our field crews don't leave the job site until the system is up and running the way it was designed — GUARANTEED!

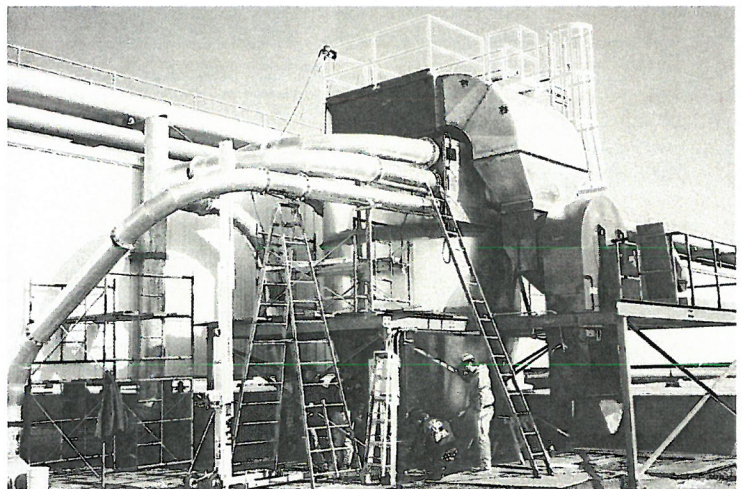

COMPLETE SYSTEM GUARANTEE.

THE BloApCo STORY



Blower Application Company, Inc. which was founded in 1933, pioneered pneumatic scrap handling systems for the paper and converting industries.

As these industries developed so did our expertise and product technology. This allowed us the opportunity to provide other companies in the can, film, foil and plastic industries with solutions to solve their scrap handling problems.

Our initial philosophy of complete customer satisfaction fueled our level of commitment to exceed customer expectations and accepted standards. This commitment propelled us to a level of quality beyond current technology; forcing us to manufacture our own equipment. The heart of the BloApCo line of products: rugged heavy duty material

handling fans, exclusive pierce-and-tear shredders and superior trim cutters, reflects a half century of innovation by our engineering staff. These products are constantly evaluated, tested and challenged to provide ground-breaking technology for future generations. Our dependability and efficiency in scrap handling applications are without parallel, and has earned us the enviable reputation as a company which builds products that deliver decades of trouble free operation.

Today BloApCo designs, engineers, manufactures, installs and guarantees the highest quality solid waste and scrap handling systems throughout the world. Any company producing scrap that needs to reduce, recycle or reuse can count on BloApCo for the best solution to their problem.

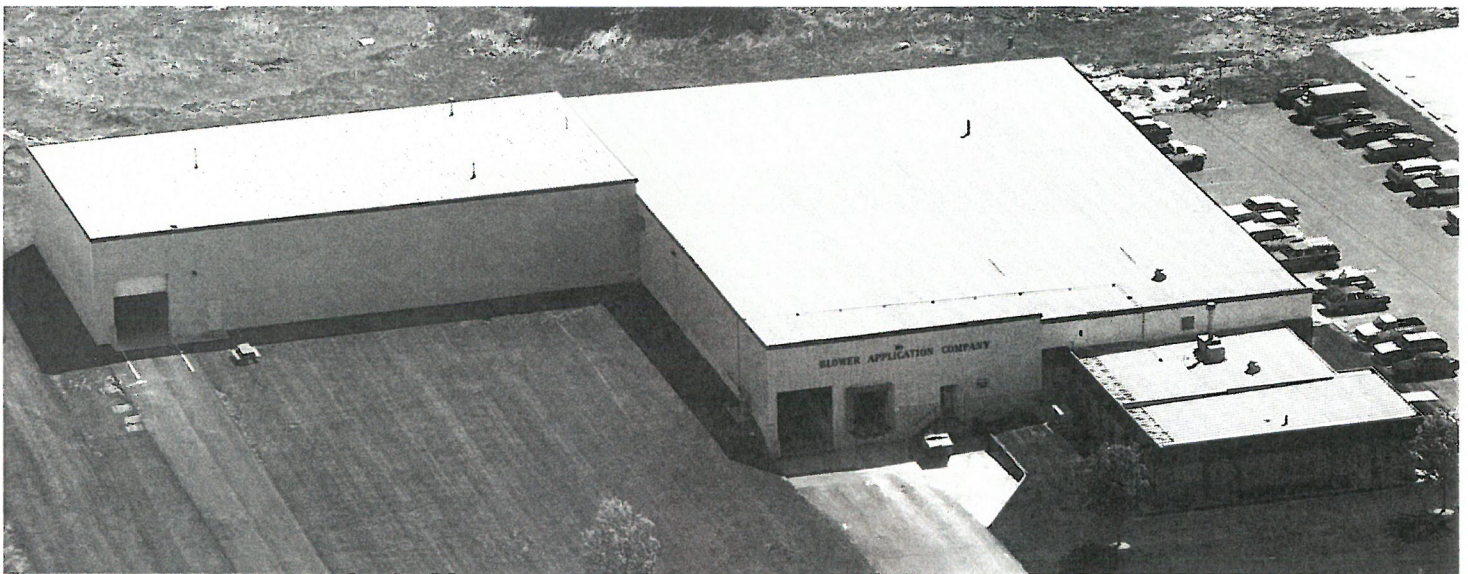

Thousands of Successful Systems Worldwide

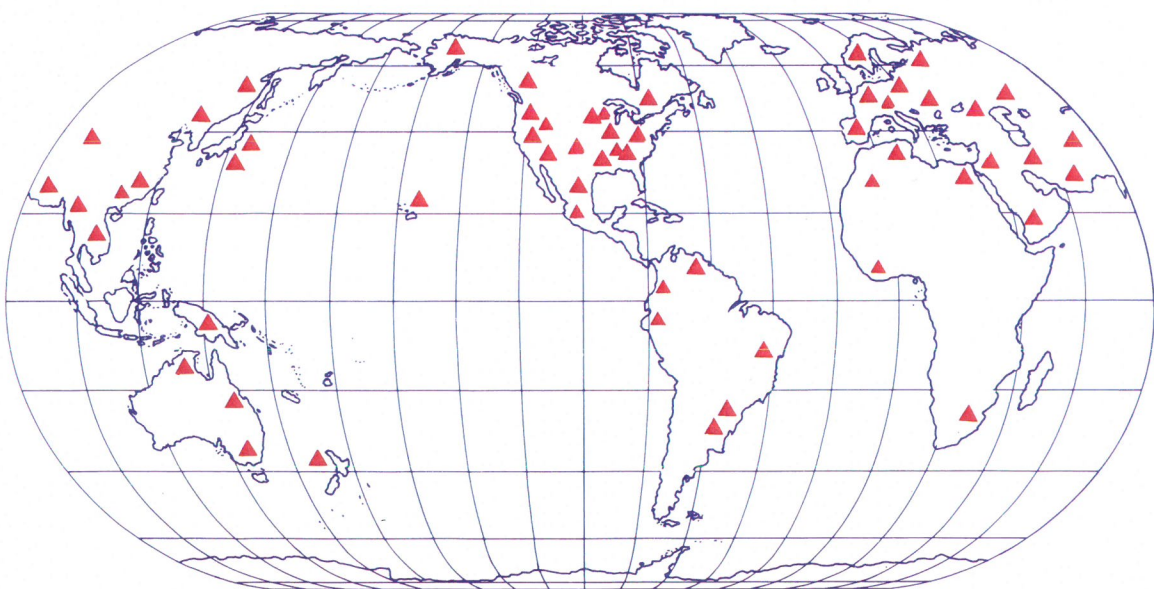

SINGLE SOURCE RESPONSIBILITY — PERFORMANCE GUARANTEED!

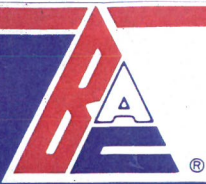

SCRAP AND WASTE HANDLING SYSTEMS USING Blower Application Co. SHREDDERS

Pallets • Plastic • Paper • Glass • Corrugated • Metal • Fiberglass

IDEAL SHREDDER APPLICATIONS

VOLUMETRIC FEEDING

When large objects or parts must be reduced to very small pieces for reprocessing, it is best to install a two-stage process. The first stage is a pierce-and-tear shredder. The shredder not only reduces to a size that a granulator or hammermill can easily handle, but it feeds them evenly. The benefits of even feeding of uniform pieces into the second stage machine are: far less maintenance, longer machine life, and less total operating costs when compared to a single stage machine.

IMPROVED BALEABILITY

Shredding newspapers, fiber cores, folding carton scrap, books and magazines, corrugated boxes, slabs of paper, and flexible polyurethane foam before baling results in: increased system thru-put, heavier bales, more uniform and better bale quality. Shredding increases the amount of material in the baling chamber. This enables the baler to cycle less and more efficiently, thus dramatically extending baler life.

SIZE REDUCTION FOR COMPACTION

Reducing large crates, boxes, skids, pallets, and parts of all sizes and description **drastically increases the amount of material that a container can hold. This will reduce haul-away costs by as much as 75%.** Systems incorporating properly designed shredders eliminate the need of an operator to break down large boxes, crates and fiberglass — the shredder does this automatically.

PRODUCT RECOVERY

Many products whose carton or container has been damaged, mislabeled or improperly filled, must be reclaimed, reprocessed and repackaged. Shredding destroys the package, thus releasing the products to be reclaimed. The shredder can also serve as an automatic bag or box opener for new products coming into a plant. Normally the packaging material is separated from the product, and automatically compacted or baled. Examples of products being reclaimed include: Soaps, flour, sugar, household liquids and fertilizers.

ENERGY RECOVERY

Shredding of all types of plant waste into uniform pieces allows plants to efficiently burn their waste — normally using the resultant generated energy to heat their building, or to produce steam for use in the manufacturing process. Burning of plant waste eliminates the need and costs associated with hauling it away to a landfill.

PRODUCT MUTILATION

Stringent quality control programs require that products not up to a company's high standards be rejected and destroyed. Shredding out of spec products ensure that they cannot be reclaimed from landfills, and returned for credit or replacement. Examples of products being shredded: athletic shoes, baked goods, aerosol cans, canned products, toys, magazines and books, non-repairable telephones, water jet skis, and fiberglass bathtubs.

CALL FOR LITERATURE or INFORMATION

BLOWER APPLICATION CO., INC.

N114 W19125 Clinton Drive • P.O. Box 279 • Germantown, WI 53022

Phone: 414-255-5580 • FAX: 414-255-3446